

MODEL: XLSM-3-66

4-PIPE "I"

MAX SPREADER LENGTH 17 FEET

KNIFE-EDGE YES

COLLAR TYPE XL SPREADER POCKETS

DATE OF MANUFACTURE Aug-13

LIFT-LUG RATING 7,344 LBS

WEIGHT AS MANUFACTURED 1,370 LBS

REFERENCE TO OCCUPATIONAL SAFETY AND HEALTH ADMINISTRATION RULES AND REGULATIONS, 29 CFR, NO 209, PART 1926, SUBPART P

SHIELD SIZE		PSF RATING	EXAMPLES OF MAXIMUM ALLOWABLE DEPTH OF CUT (FEET) IN SOIL TYPE TO BE EXCAVATED		
HEIGHT (FEET)	LENGTH (FEET)	MAXIMUM LATERAL EARTH PRESSURE CAPACITY AT TRENCH BOTTOM IN POUNDS PER SQUARE FOOT	TYPE B-45 (II) MEDIUM COHESIVE TO GRANULAR SOIL 45 PSF PER FT OF DEPTH	TYPE C-60 (III) SOFT COHESIVE TO SATURATED SOIL. 60 PSF PER FT OF DEPTH	TYPE C-80 (IV) SOFT SUBMERGED AND FLOWING SOIL. 80 PSF PER FT OF DEPTH
6	6	1200	27	20	15

LIMITATIONS IN USE OF TABLE

- TRENCH SHIELD TO BE ASSEMBLED AND INSTALLED IN ACCORDANCE WITH MANUFACTURER'S INSTRUCTIONS. (SEE PAGE-2)
- EXCAVATION 2 FEET BELOW BOTTOM OF SHIELD IS PERMITTED WHEN NO LOSS OF SOIL FROM BEHIND OR BELOW THE BOTTOM OF SHIELD IS ENCOUNTERED. SEE PARAGRAPH 1926.652 (e)(2)(i). THE COMPETENT PERSON SHALL MAKE THE DETERMINATION FOR COMPLIANCE. SUDDEN SHIFTING OF THE SHIELD VERTICALLY SHALL BE AVOIDED.
- DEPTH RATING IS BASED ON TEMPORARY LOADING, CONSULT MANUFACTURER IF SHIELD IS SUBJECT TO LONG TERM LOADING
- ADDITIONAL SHIELDS MAY BE STACKED WITH NO PENALTY IN DEPTH OF CUT AS LONG AS THE RATING OF THE EACH SHIELD IS NOT EXCEEDED AT THE DEPTH IT IS USED. MANUFACTURER APPROVED STACKING METHOD MUST BE USED.
- C-80 DOES NOT REPRESENT THE WORST POSSIBLE SOIL CONDITION. OBTAIN SITE-SPECIFIC ENGINEERING FOR EXTREMELY NON-STABLE CONDITIONS SUCH AS MARINE CLAY, PEAT, SOFT SUBMERGED AND FLOWING CLAYS, ETC.
- ANY MODIFICATIONS OR ALTERATIONS NOT ALLOWED UNLESS APPROVED IN WRITING BY EFFICIENCY PRODUCTION, INC.
- CONTRACTOR'S COMPETENT/QUALIFIED PERSON SHALL BE RESPONSIBLE FOR MONITORING SOIL CONDITIONS AND SHALL BE RESPONSIBLE FOR COMPLIANCE WITH ALL FEDERAL, STATE AND LOCAL LAWS, RULES, AND REGULATIONS.
- SPREADER PINS SHALL BE 8620 COLD DRAWN 80-90 KSI MIN. YIELD AND NO MORE THAN 1/4" SMALLER THAN COLLAR AND SPREADER PIN HOLES AS MANUFACTURED BY EFFICIENCY PRODUCTION, INC.
- LIFT LUG RATING IS (THE SAFE WORKING LOAD) FOR EACH INDIVIDUAL LIFT LUG.
- WEIGHT LISTED IS FOR SHIELD ONLY. USE ASSEMBLED WEIGHT INCLUDING SPREADERS FOR RIGGING PURPOSES

DESCRIPTION	DESCRIPTION	DESCRIPTION
CLAY, WITH UNCONFINED COMPRESSIVE STRENGTH GREATER THAN 0.5 TSF BUT LESS THAN 1.5 TSF COHESIONLESS GRAVEL, SILT, SILT LOAM OR SANDY LOAM	SOFT COHESIVE SOIL UNCONFINED COMPRESSIVE STRENGTH GREATER THAN 0.2 TSF, BUT LESS THAN 0.5 TSF CLAY, SAND AND LOAMY SAND; SATURATED SOIL THAT IS STABLE, DRY SAND, OR DEWATERED SOILS	SOFT COHESIVE SOIL UNCONFINED COMPRESSIVE STRENGTH LESS THAN 0.2 TSF. FRACTURED ROCK THAT IS NOT STABLE, OR SUBMERGED SAND AND LOAMY SAND THAT IS FLOWING. (SEE NOTE 5)

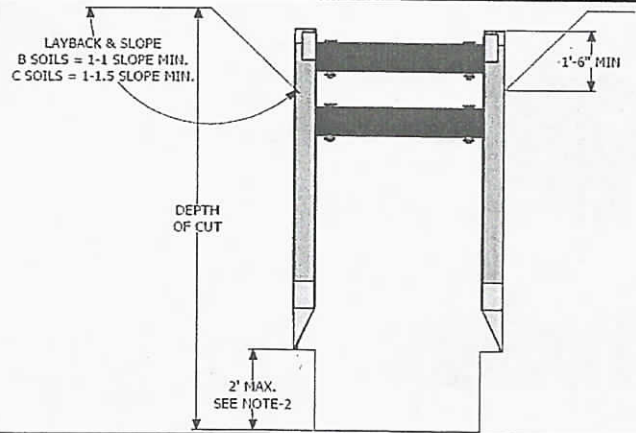

MANUFACTURED UNDER ONE OR MORE OF THE FOLLOWING U.S. PATENT NUMBERS: 4,090,365-4,114,383-4,259,028 ONE OR MORE OF THE FOLLOWING CANADIAN PATENT NUMBERS: 1,062,683-1,062,684

CERTIFIED BY:
EFFICIENCY PRODUCTION INC.

COPYRIGHT: 1991
EFFICIENCY PRODUCTION INC.
ALL RIGHTS RESERVED

CONTINUED ON REVERSE SIDE



8/5/2013

- NOT TYPE A IF FISSURED, SUBJECT TO VIBRATION, PREVIOUSLY DISTURBED OR PART OF A SLOPED LAYERED SYSTEM WHERE LAYERS DIP INTO EXCAVATION ON A SLOPE OF FOUR HORIZONTAL TO ONE VERTICAL (4H:1V) OR GREATER.
- PREVIOUSLY DISTURBED SOILS MAY BE TYPE B UNLESS THEY WOULD BE CLASSIFIED AS TYPE C. SOIL THAT MEETS THE REQUIREMENTS OF TYPE A, BUT IT IS SUBJECT TO VIBRATION OR FISSURED MAY BE TYPE B. DRY ROCK THAT IS NOT STABLE OR SOIL THAT IS PART OF A SLOPED, LAYERED SYSTEM WHERE LAYERS DIP INTO THE EXCAVATION ON A SLOPE LESS STEEP THAN FOUR HORIZONTAL TO ONE VERTICAL (4H:1V) ARE TYPE B BUT ONLY IF MATERIAL WOULD OTHERWISE BE CLASSIFIED AS TYPE B.
- SOIL IN A SLOPED LAYERED SYSTEM WHERE LAYERS DIP INTO THE EXCAVATION ON A SLOPE OF FOUR HORIZONTAL TO ONE VERTICAL (4H:1V) OR STEEPER MAY BE TYPE C. SUBMERGED SOIL IS MATERIAL WITH WATER FREELY SEEPING AND ENTERING THE TRENCH, BUT ONLY PART OF THE DEPTH OF THE RETAINED SOIL IS SUBMERGED. CONDITIONS MORE SEVERE WOULD REQUIRE DEWATERING OR SEALING FOUR SIDES OF THE EXCAVATION AND PUMPING THE TRENCH, SUCH SEVERE CONDITIONS WOULD REQUIRE THE SERVICES OF A SOILS ENGINEER TO ESTABLISH THE DESIGN PRESSURE. CONSULT THE MANUFACTURER FOR PRESSURES EXCEEDING TABULATED VALUES.
- ANY SOIL THAT WILL STAND UNSUPPORTED LONG ENOUGH TO INSTALL TRENCH SHIELD MAY BE CLASSIFIED AS C-60
- ANY USE OF A TRENCH SHIELD WITHOUT EFFICIENCY SPREADERS AND PINS OR EQUAL WILL VOID THE TABULATED DATA AND WARRANTY.
- SHIELD WAS DESIGNED TO BE USED WITHOUT PLATES EXTENDING BELOW, ABOVE, OR NEXT TO IT. ANY USE OF SUCH PLATES OR PANELS MAY VOID THE TABULATED DATA AND MAY REQUIRE SITE SPECIFIC ENGINEERING.
- TRENCH SHIELDS ARE DESIGNED TO BE PUSHED TO GRADE IF NECESSARY. AS NOTED BELOW, ANY UNNECESSARY ABUSE BY THE EXCAVATOR AND OR OPERATOR (SUCH AS POUNDING WITH THE BUCKET) WILL VOID THE TABULATED DATA AS WELL AS THE WARRANTY.
- CONDITION OF SHIELD, SPREADER PIPES, AND SPREADER PINS MUST BE CHECKED/ INSPECTED FOR SERVICEABILITY BY THE COMPETENT PERSON PRIOR TO EACH USE. PSF RATING IS NOT VALID IF THERE IS ANY VISIBLE DAMAGE TO, OR REPAIRS MADE TO THE SHIELD THAT HAS NOT BEEN DOCUMENTED AND CERTIFIED BY A REGISTERED PROFESSIONAL ENGINEER.
- A MINIMUM OF 2 SPREADERS, 1 ARCH, OR 1 SPREADER AND 1 MUDPLATE MUST BE INSTALLED ON EACH END OF TRENCH SHIELD PRIOR TO USE.
- DEPTH AND PSF RATING ARE FOR LATERAL EARTH PRESSURES ONLY AND DO NOT TAKE ANY SURCHARGES INTO ACCOUNT.

ASSEMBLY

MUDPLATE SPREADERS SYSTEM 5 PIPE SPREADER SYSTEM

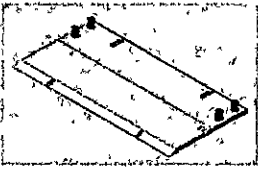

LAY SIDE PANEL FLAT ON GROUND WITH COLLAR SOCKETS UP

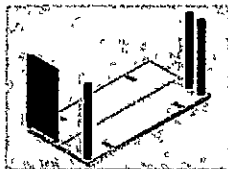

PLACE SPREADER PIPE AND/OR PLATE ON TO COLLARS OR INTO BRACKETS AND PIN IN PLACE. SECURE PINS WITH KEEPERS

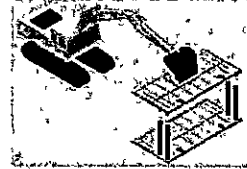
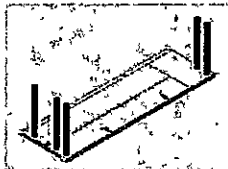

LOWER SECOND SIDEWALL ONTO SPREADERS AND PIN

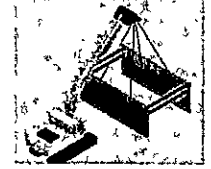

STAND TRENCH SHIELD IN UPRIGHT POSITION AND PREPARE FOR INSTALLATION

USING A TRENCH SHIELD IN STABLE SOIL

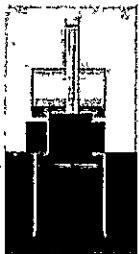

EXCAVATE TO GRADE JUST SLIGHTLY WIDER THAN THE TRENCH SHIELD. DIG WALLS VERTICAL TO MINIMUM OF 18" BELOW THE TOP OF THE SHIELD. SLOPE SOILS ABOVE SHIELD ACCORDING TO MANUFACTURERS TABULATED DATA. INSTALL SHIELD IN TRENCH.



EXCAVATE IN FRONT OF THE TRENCH SHIELD

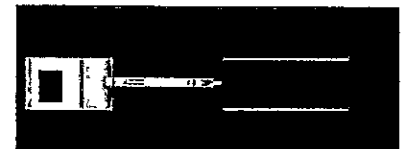

PULL SHIELD FORWARD BY FRONT TOP SPREADER PIPE OR WITH PULLING EYES. (PULLING EYES SHALL BE USED WITH SPREADERS WIDER THAN 72" OR WHEN SOIL PRESSURE IS SEVERE ENOUGH TO CAUSE SPREADER TO DEFLECT).

USING A TRENCH SHIELD IN UNSTABLE SOIL

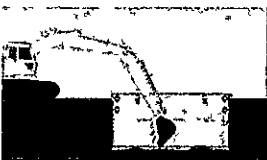

EXCAVATE UNTIL SOIL BEGINS TO CRUMBLE BEYOND DESIRED TRENCH WIDTH. PLACE SHIELD IN LINE OF EXCAVATION



PRESS DOWN ON CORNERS TO PUSH SHIELD DOWN TO GRADE

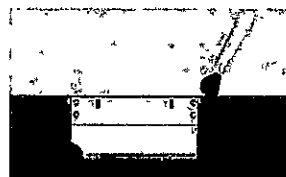

PULL SHIELD FORWARD AND UP ON APPROPRIATE ANGLE



EXCAVATE SOIL WITHIN THE SHIELD AND REPEAT PREVIOUS PROCESS

USING TRENCH SHIELDS FOR PATCHWORK, REPAIRS OR TIE-INS

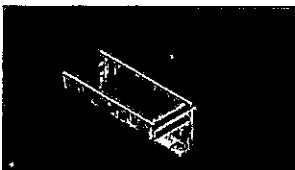

*CENTER SHIELD OVER WORK AREA
*LAY SOIL AT ENDS BACK ACCORDING TO MANUFACTURER'S TABULATED DATA OR USE MANUFACTURER'S DESIGNED PLATES TO PROTECT FROM CAVE-INS

MANHOLE BOX W/CORNER END PLATES

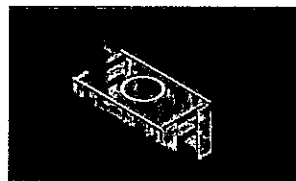

CORNER END PLATES HELP PREVENT LOOSE MATERIAL FROM RUNNING INTO THE END OF THE SHIELD. SOIL AT ENDS SHOULD BE SLOPED ACCORDING TO MANUFACTURER'S TABULATED DATA

USING 4-SIDED SHIELDS

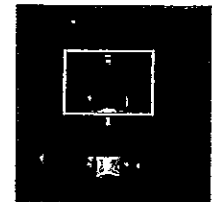

WHEN USING SHIELDS AS PROTECTION DURING MANHOLE ASSEMBLY WORK, INSURE THAT PROPER END PANELS ARE USED, OR LAY SOIL AT THE ENDS BACK ACCORDING TO MANUFACTURER'S TABULATED DATA

*THIS MATERIAL IS INTENDED TO PROVIDE BASIC ASSEMBLY AND INSTALLATION INFORMATION ONLY.

*ALWAYS USE TRENCH SHIELD IN ACCORDANCE WITH APPLICABLE LOCAL, STATE, AND FEDERAL SAFETY LAWS AND REGULATIONS.

*FAILURE TO DO SO COULD CAUSE SEVERE INJURY OR DEATH.